

91

Suitable for all types of private swimming pools, commercial swimming pools and spas.

MONITORING DISINFECTION EQUIPMENT



MEDIUM PRESSURE UV STERILIZER

AIUV

Quartz Sleeve Manual Wiper



AIUV

Quartz Sleeve Automatic Wiper



MUV

Quartz Sleeve Manual Wiper



- Imported lamps.
- Quartz sleeve manual / automatic wiper.
- All physical disinfection, safe and healthy.
- Ultraviolet light automatically starts and stops.

The high-intensity medium-pressure UV lamp has an output wavelength between 200nm and 400nm and contains wavelengths of 245nm, 297nm and 340nm required to reduce chloramine. The effective control of chloramine can better protect the safety of swimmers and workers, and avoid the stress corrosion of steel structures caused by excessive concentration of chloramine in indoor swimming pools.

Control Box:

- Imported brand electronic accessories.
- Lamp failure alarm.
- Water flow start protection.
- Real-time monitoring of working current.
- System failure alarm.
- System overheat protection.
- I/O or remote PLC control.



I/O



PLC



AIUV Series



Model-Manual	Model-Automatic-1	Model-Automatic-2	Number of Tubes	Power	Voltage	Connection Size	Maximum Flow
				(kW)	(V/Hz)		
AIUV600W1NW80-NW	AIUV600W1NW80-AW	AIUV600W1NW80-AW-T	1	0.6	220/50	DN80	30
AIUV2K1NW100-NW	AIUV2K1NW100-AW	AIUV2K1NW100-AW-T	1	1	220/50	DN100	50
AIUV4K3NW100-NW	AIUV4K3NW100-AW	AIUV4K3NW100-AW-T	1	2	380/50	DN100	90
AIUV6K3NW150-NW	AIUV6K3NW150-AW	AIUV6K3NW150-AW-T	1	3	380/50	DN150	200
AIUV8K3NW200-NW	AIUV8K3NW200-AW	AIUV8K3NW200-AW-T	2	4	380/50	DN200	270
AIUV12K3NW250-NW	AIUV12K3NW250-AW	AIUV12K3NW250-AW-T	2	6	380/50	DN250	480
AIUV16K3NW300-NW	AIUV16K3NW300-AW	AIUV16K3NW300-AW-T	4	8	380/50	DN250/DN300	580
AIUV24K3NW300-NW	AIUV24K3NW300-AW	AIUV24K3NW300-AW-T	4	12	380/50	DN300	750

MUV Series



Model	Voltage	Connection Size	Number of Tubes	Power	Maximum Flow	Control Box Size
	(V/Hz)			(kW)	(m ³ /h)	(mm)
MUV2K1NW80	220/50	DN80	1	1	50	600x600x210
MUV4K3NW100	380/50	DN100	1	2	90	600x600x210
MUV6K3NW150	380/50	DN150	1	3	200	600x760x350
MUV8K3NW200	380/50	DN200	2	4	270	600x760x350
MUV12K3NW250	380/50	DN250	2	6	480	600x760x350
MUV16K3NW300	380/50	DN250/DN300	4	8	580	600x1000x350
MUV24K3NW300	380/50	DN300	4	12	750	600x1000x350

STAINLESS STEEL UV STERILIZER

Suitable for pool water, landscape water, cooling water, seawater desalination, small water flow disinfection and so on.

- UV lamp.
- High transmittance quartz sleeve.
- Electronic ballast.
- 304/316 stainless steel reactor.
- Electric control box.

- Imported Light Source original UV lamps, long life up to 8000 hours.
- 304 stainless steel sandblasted electroplated housing.
- Intelligent control electric box: Control three-way output (two-way standby). Temperature display, high temperature alarm, temperature 55°C. Timing switch machine, water pump linkage.
- High transmittance quartz sleeve.

- UV lamp.
- High transmittance quartz sleeve.
- Electronic ballast.
- 304/316 stainless steel reactor.
- The electronic control box (time cumulative device, warning indicator) mirrors.
- Manual / automatic cleaning (optional).

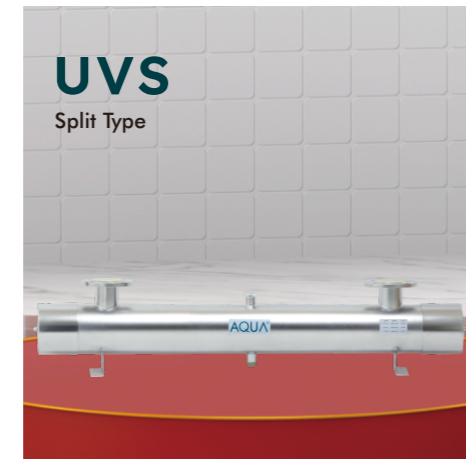

UV sterilizer widely used in water treatment is extremely valuable, through ultraviolet light irradiation, it can damage and change the DNA structure of microorganisms, the bacteria immediately died or can not reproduce the offspring in order to achieve the purpose of sterilization. It is a physical disinfection method that does not cause secondary pollution of water and the surrounding environment. Stainless steel UV sterilizer has anti-corrosion, long service life stainless steel shell.

STAINLESS STEEL UV STERILIZER

UVA Series Stainless Steel UV Sterilizer

Model	Voltage	Working Pressure	Flow	Lamp Configuration	Connection Size	Dimensions
	(V/Hz)	(Mpa)	(m ³ /h)	(W)		(mm)
UVA-80	220/50	0.6	10	40x2	DN40	950x140x305
UVA-120	220/50	0.8	15	40x3	DN50	950x140x330
UVA-180	220/50	0.8	22	40x4	DN50	950x155x345



UVS Series Stainless Steel UV Sterilizer

Model	Voltage	Working Pressure	Flow	Lamp Configuration	Lamp Power	Connection Size	Dimensions
	(V/Hz)	(Mpa)	(m ³ /h)	(W)	(W)		(mm)
UVS-85N	220/50	0.7	18	87x1	87	DN40	1080x100x220
UVS-170N	220/50	0.7	30	87x2	174	DN40	1080x140x240
UVS-240N	220/50	0.7	40	120x2	240	DN65	1390x170x320
UVS-360N	220/50	0.7	60	120x3	360	DN80	1390x190x350



UVF Series Stainless Steel UV Sterilizer

Model	Voltage	Working Pressure	Flow	Lamp Configuration	Connection Size	Dimensions
	(V/Hz)	(Mpa)	(m ³ /h)	(W)		(mm)
UVF-240	220/50	0.6	30	120x2	DN65	1260x210x360
UVF-360	220/50	0.6	40	120x3	DN80	1260x210x375
UVF-480	220/50	0.6	50	120x4	DN100	1260x250x450
UVF-600	220/50	0.6	65	120x5	DN100	1260x250x450
UVF-720	220/50	0.6	75	120x6	DN100	1260x250x450
UVF-960	220/50	0.6	90	120x8	DN150	1260x300x555
UVF-1080	220/50	0.6	100	120x9	DN150	1260x300x555
UVF-1200	220/50	0.6	120	120x10	DN150	1260x300x555
UVF-1920	220/50	0.6	180	320x6	DN200	1665x350x665
UVF-2560	220/50	0.6	220	320x8	DN250	1665x440x680
UVF-3520	220/50	0.6	360	320x11	DN250	1665x440x680
UVF-4800	220/50	0.6	480	320x15	DN250	1665x520x815
UVF-6400	220/50	0.6	600	320x20	DN350	1665x600x1060
UVF-7040	220/50	0.6	660	320x22	DN350	1665x600x1060



AMALGAM UV STERILIZER

PL Suitable for hot spring pools within 90°C.

Professional for sterilization and eliminating algae in spring water, seawater, swimming pool, SPA pool and landscaped pool.

Amalgam lamps are the amalgam UV germicidal lamp. Amalgam is an alloy of mercury with another metal. When amalgam lamps in the excitation voltage, a steady wavelength of 254nm and 185nm UV light is emitted.

- More solid: The shell material is imported, withstanding pressure, corrosion resistance.
- Security: Built-in water level switch and temperature switch in the electric box.
- Easy installation: Vertical installation, floor fixed, 4" standard flange connection.
- More efficient: Imported amalgam lamp, life up to 16,000 hours.
- More stringent: The lamp and quartz sleeve's packaging more stringent.

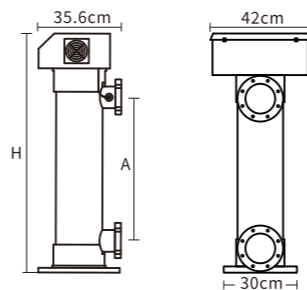

PL Series Amalgam UV Sterilizer

Model	Voltage (V/Hz)	Working Pressure (kg/cm ²)	Flow (m ³ /h)	Power (W)	Connection Size	Operating Temperature (°C)	H (mm)	A (mm)
PL-III	220/50	4	54	127	DN100	2-90	1135	720
PL-IV	220/50	4	80	207	DN100	2-90	1285	870



UV STERILIZER

PM Suitable for sterilization and eliminating algae in spring water, seawater, swimming pool, SPA pool and landscaped pool.



Union



Water Proof and UV Resistant Control Box

- Original imported UV lamp, service life up to 10000 hours.
- High transmittance quartz sleeve.
- Ballast (more than 5 years service life, with a warning indicator).
- High-strength plastic housing.
- With electric control box.
- Two options: Vertical installation or horizontal installation.

PM Series UV Sterilizer



Horizontal



Vertical

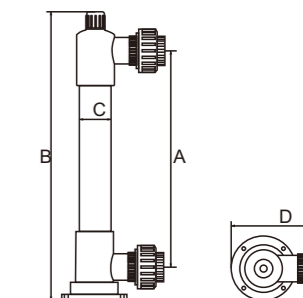

Compound Mode:

Model	Voltage (V/Hz)	Working Pressure (kg/cm ²)	Flow (m ³ /h)	Power (W)	Connection Size	Operating Temperature (°C)	Size A/B/C/D (mm)
PM-III	220/50	2.8	18	87	DN50	2-40	743/970/114/284
PM-IV	220/50	2.8	23	120	DN50	2-40	1038/1265/114/284

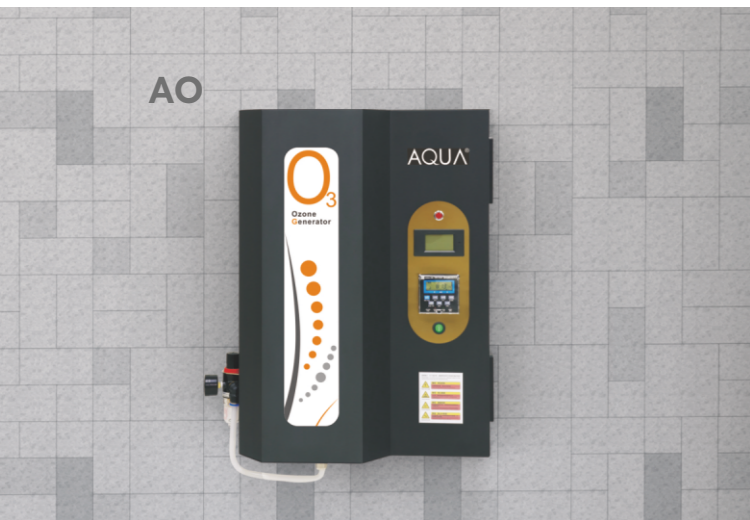

AO series ozone generator casing--SS304 material. The machine surface adopts spraying technology, fine production, frosted texture.

AO

-Digital display shows current and voltage.
-With time controller (set long-term cycle at a time).

- External air filter, automatic drainage.
- There are 2 exhaust fans, the air enters below and it is exhausted above. Quiet axial flow fan for less noise and greater air volume (3.25 cubic meters per minute).
- The air inlet is made of SS304, and the ozone outlet is made of SS316 which ensure that the ozone outlet is minimally corroded by ozone.
- The time controller can be set to open/close at different times of the day.

QHW



QHW timing setting, temperature setting, working time accumulation, water flow switch, intelligent control panel. The housing is made of SS304, sprayed, painted and equipped with an air filter.

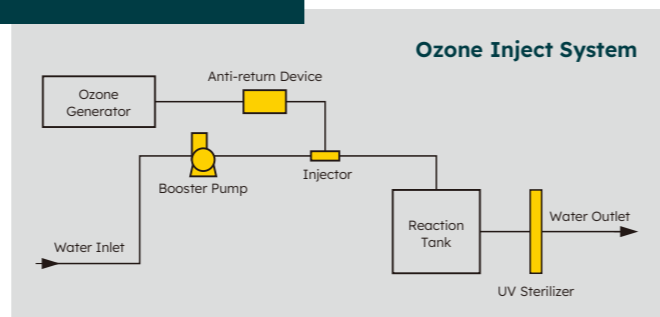

OZONE GENERATOR

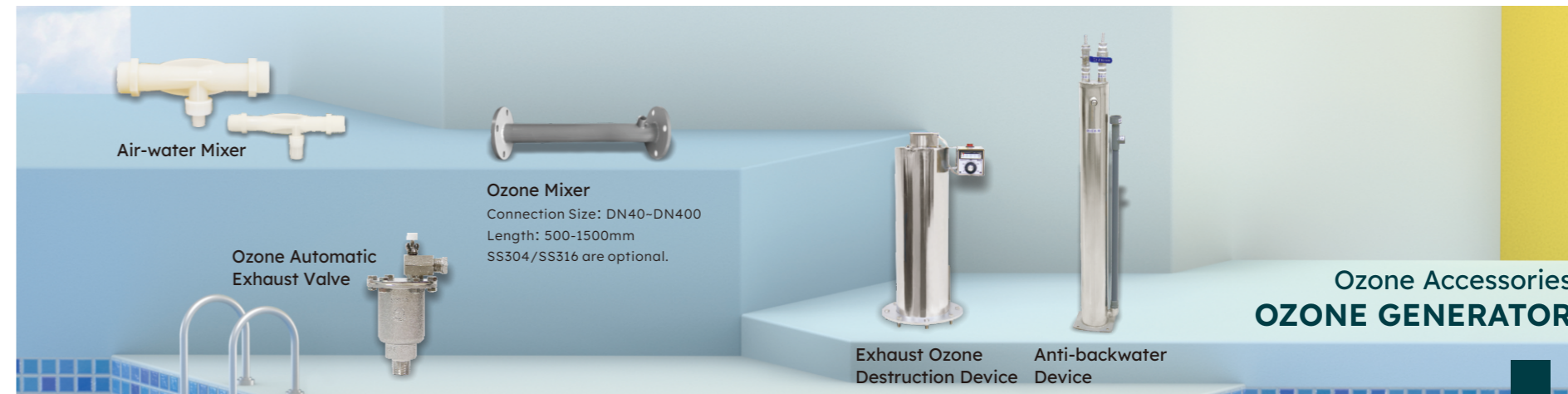

AO Series Ozone Generator



Model	Voltage	Ozone Output	Current	Power	Dimensions	Cooling Method
	(V/Hz)	(g/h)	(A)	(W)	(mm)	
AO-060N	220/50	6	<0.23	50	400x230x500	Air Cooled
AO-120N	220/50	12	<0.45	100	400x230x500	Air Cooled
AO-200N	220/50	20	<0.9	200	450x250x630	Air Cooled
AO-300N	220/50	30	<1.3	280	450x250x630	Air Cooled
AO-400N	220/50	40	<1.5	320	650x280x800	Air Cooled/Water Cooled
AO-500N	220/50	50	<2.0	450	650x280x800	Air Cooled/Water Cooled
AO-600N	220/50	60	<2.2	480	650x280x800	Air Cooled/Water Cooled

QHW Series Ozone Generator



Model	Voltage	Ozone Output	Power	Dimensions	Ozone Pipe	Suitable Booster Pump	Suitable Injector
	(V/Hz)	(g/h)	(W)	(mm)	(mm)	(HP/V)	
QHW-80N	220/50	80	640	600x450x1300	12x8	3/380	DN40
QHW-100N	220/50	100	1000	600x450x1300	12x8	3/380	DN40
QHW-150N	220/50	150	1200	750x550x1450	12x8	3/380	DN40
QHW-200N	220/50	200	2000	750x550x1450	12x8	3/380	DN50
QHW-250N	220/50	250	2200	850x550x1600	12x8	3/380	DN50
QHW-300N	220/50	300	3000	850x550x1600	12x8	3/380	DN50



AWO OZONE INTEGRATED MACHINE

AWO series ozone integrated machine use high quality ozone generator. The whole main body are made of 304 stainless steel. It integrates ozone generator, booster pump, venturi injector, ozone mixing tower for pool and SPA water.

AWO ozone purifies pool and SPA water to make it pure and transparent, so that the demand for the chemicals reducing 90%. It's advanced anti-return design greatly increase the life of the ozone generator.

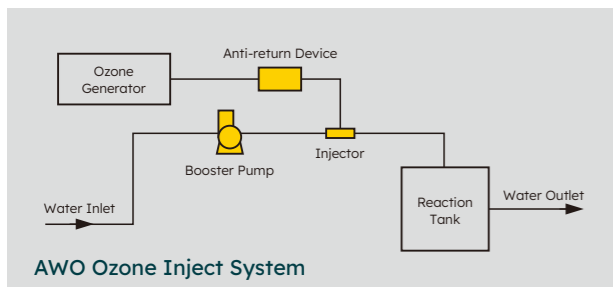

AUO OZONE INTEGRATED MACHINE

Including UV Light

AUO ozone and UV purify swimming pool and SPA water to make it pure and transparent. Reduce the demand for chemicals by 90% while neutralizing all pungent and irritating pool chemical by-products.. It's advanced anti-return design greatly increase the life of the ozone generator.

AUO series ozone integrated machine use high quality ozone generator. The whole main body are made of 304 stainless steel. It integrates ozone generator, UV sterilizer, booster pump, venturi injector, ozone mixing tower for pool and SPA water.

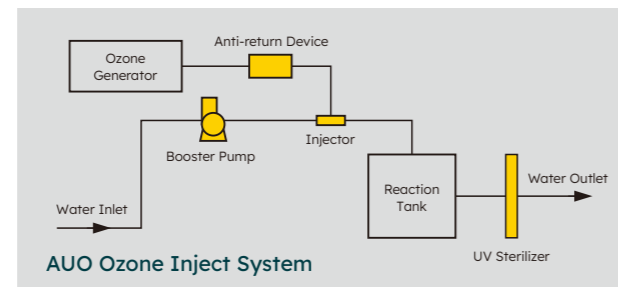

QY OXYGEN SOURCE OZONE GENERATOR

- Uses a high-temperature resistant titanium HQG non-glass structure discharge high frequency and high voltage unit.
- Standard 4~20mA signal access port, the ozone production can be automatically and accurately controlled by various external detectors.
- Multiple fault point monitoring functions, main PCB temperature detection, high-voltage package temperature detection, cooling water temperature detection, PSA system gas source temperature detection, ozone generation pipe return water detection, etc..
- Using air as raw material, low power consumption, and low oxygen production cost.
- Stable performance, low-pressure gas circuit systems, safe and reliable operation.
- Adjustable oxygen flow, large oxygen supply, low noise.
- Easy operation, on-demand production, and continuous oxygen supply.

AWO Series Ozone Integrated Machine



Model	Voltage (V/Hz)	Water Inlet	Water Outlet	Ozone Concentration (mg/L)	Total Power (W)	Maximum Ozone Output (g/h)	Reaction Tank Specifications (mm)	Ozone Generator Power (W)	Booster Pump Power (W)	Dimensions (mm)	Suitable for Pool Volume (m³)
AWO-5	220/50	DN25	DN25	15-25	1150	5	Ø300x1200	50	1100	1000x500x1450	75-150
AWO-10	220/50	DN25	DN25	15-25	1180	10	Ø300x1200	80	1100	1000x500x1450	150-250
AWO-15	220/50	DN25	DN25	15-25	1220	15	Ø400x1600	120	1100	1000x500x1750	225-400
AWO-20	220/50	DN25	DN25	15-25	1260	20	Ø400x1600	160	1100	1000x500x1750	300-500
AWO-30	220/50	DN25	DN40	15-25	1340	30	Ø500x1600	240	1100	1100x600x1750	450-600
AWO-40	220/50	DN50	DN40	15-25	2520	40	Ø500x1600	320	2200	1100x600x1750	670-800
AWO-50	220/50	DN50	DN40	15-25	2600	50	Ø600x1600	400	2200	1100x600x1750	750-900
AWO-60	220/50	DN50	DN40	15-25	2650	60	Ø600x1600	450	2200	1100x600x1750	900-1100

AUO Series Ozone Integrated Machine



Model	Voltage (V/Hz)	Water Inlet	Water Outlet	Ozone Concentration (mg/L)	Total Power (W)	Maximum Ozone Output (g/h)	Reaction Tank Specifications (mm)	UV Power (W)	Ozone Generator Power (W)	Booster Pump Power (W)	Dimensions (mm)	Suitable for Pool Volume (m³)
AUO-5	220/50	DN25	DN40	15-25	1190	5	Ø300x1200	40	50	1100	1000x600x1450	75-150
AUO-10	220/50	DN25	DN40	15-25	1220	10	Ø300x1200	40	80	1100	1000x650x1450	150-250
AUO-15	220/50	DN25	DN40	15-25	1260	15	Ø400x1600	40	120	1100	1000x650x1750	225-400
AUO-20	220/50	DN25	DN40	15-25	1340	20	Ø400x1600	80	160	1100	1000x650x1750	300-500
AUO-30	220/50	DN25	DN40	15-25	1420	30	Ø500x1600	80	240	1100	1100x750x1750	450-600
AUO-40	220/50	DN50	DN40	15-25	2640	40	Ø500x1600	120	320	2200	1100x750x1750	670-800
AUO-50	220/50	DN50	DN40	15-25	2720	50	Ø600x1600	120	400	2200	1200x850x1750	750-900
AUO-60	220/50	DN50	DN40	15-25	2870	60	Ø600x1600	120	450	2200	1200x850x1750	900-1100

QY OXYGEN SOURCE OZONE GENERATOR

NEW



Model(Regular)	QY-10	QY-20	QY-30	QY-40	QY-50	QY-60	QY-80	QY-100	QY-150	
Model(PLC)	QY-10-AI	QY-20-AI	QY-30-AI	QY-40-AI	QY-50-AI	QY-60-AI	QY-80-AI	QY-100-AI	QY-150-AI	
Ozone Output	g/h	10	20	30	40	50	60	80	100	150
Power Frequency	W	960	1070	1200	1360	1400	1500	2300	2500	3000
Rated Working Current	A	3.9	4.4	4.9	5.6	5.7	6.1	9.4	10.2	12.3
Power	V/Hz	220/50	220/50	220/50	220/50	220/50	220/50	220/50	220/50	220/50
Working Pressure	kg/cm²	≤1.0	≤1.0	≤1.0	≤1.0	≤1.0	≤1.0	≤1.0	≤1.0	≤1.0
Oxygen Concentration	/	90%±5	90%±5	90%±5	90%±5	90%±5	90%±5	90%±5	90%±5	90%±5
Cooling Mode	/	Air-cooled	Air-cooled	Air-cooled	Water-cooled	Water-cooled	Water-cooled	Water-cooled	Water-cooled	Water-cooled
Operating Ambient Temperature	°C	<37	<37	<37	<37	<37	<37	<37	<37	<37
Operating Ambient Humidity	RH	<70%	<70%	<70%	<70%	<70%	<70%	<70%	<70%	<70%
Ozone Outlet	mm	8mm Female thread								
Connecting Cable	mm²	3*0.75	3*0.75	3*0.75	3*1.5	3*1.5	3*1.5	3*2.5	3*2.5	3*4
Dimensions	Length	mm	500	500	500	500	800	800	800	1000
	Width	mm	390	390	390	390	600	600	600	600
	Height	mm	1200	1200	1200	1200	1300	1300	1300	1600
Weight	kg	55	60	67	72	55	60	85	95	110

*The AI model is PLC+color screen control system

WATER QUALITY MONITOR

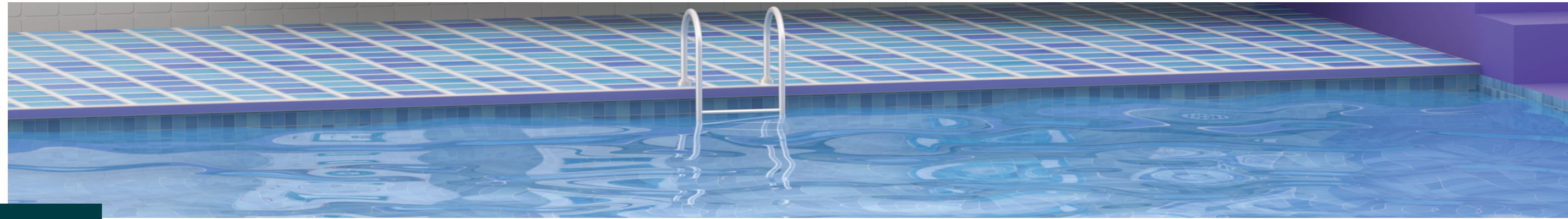

AUT-3000 Multi-parameter PLC Water Quality Monitor



pH measurement -- range: 0.0~14.0
ORP measurement -- range: ±2000mV
CL measurement -- range: 0-2PPM (0~20PPM Optional)
Temperature measurement -- range: 0~99°C
Turbidity measurement -- range: 0~10NTU
Power input -- 220V/50Hz
Power -- 50W
Output -- RS485 communication protocol, 3 dosing pump relay output
Data display -- 7-Inch touch LCD screen
Dimension -- 700(H)x500(W)x150(D)mm
Installation -- wall-mounting
Weight -- 20kg
Protection degree -- IP65

7-inch Color LCD Display

- Remote monitoring via mini-program and web page.
- Customized system, expandable parameters such as conductivity, ozone, water flow, pressure, etc..
- Password protection to prevent misoperation.
- Delivery as a whole, easy to install.
- Built-in wifi, mobile hotspot connection, optional 4G network.
- Integrated drainage system integration.
- Multiple optional remote data links.
- Parameter personalized customization combination, flexible combination according to customer monitoring needs.
- Remote real-time monitoring, historical records, data analysis, alarm, etc..

AUT-2000



Remote Multi-parameter Water Quality Monitor

pH measurement -- range: 0.0~14.0, Accuracy: ±0.1
ORP measurement -- range: 200~1000mV, Accuracy: ±1
CL measurement -- range: 0~2PPM, Accuracy: ±0.01
Temperature measurement -- PT100, range: 0~100°C, Accuracy: 1°C
Turbidity measurement -- range: 0~10NTU, Accuracy: ±0.1
Power input -- 220V/50Hz
Power -- 30W
Output -- RS485 communication protocol, 4 dosing pump relay output
Data display -- 7-Inch touch LCD screen
Dimension -- 420 (H)x315 (W)x160 (D)mm
Installation -- wall-mounting
Working environment -- Temperature: 0~40°C; Relative Humidity: 0~95% (non-condensing)
Weight -- 2.4kg
Housing material -- ABS
Protection degree -- IP65

7-inch Color LCD Display

- Automatic monitoring, recording, store and transmit data to the data monitoring platform.
- Can view and analyze data remotely.
- Multiple people sharing data and one person monitoring multiple devices.
- Can check the historical data curve.
- Multi-channel dosing pump output, automatic/manual switch.
- Two levels of password protection.
- All parameters can be calibrated.
- Value is too high or too low alarm function.
- Built-in remote module.

AUT-1000



Four Lines of 16 Characters LCD Display

AUT-1000 using high quality electronic components and excellent housing material. It is a pool water quality intelligent monitoring system, designed to control ORP and pH valve of swimming pool and SPA pool.

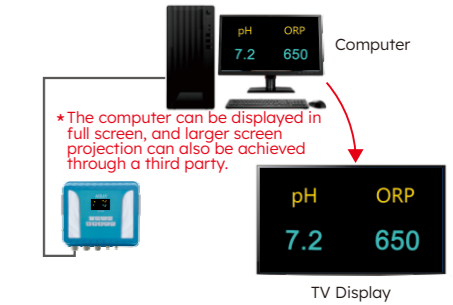

Power input -- 220V/50Hz
Power -- 15W
Operating environment -- 0~40°C
Relative humidity -- 0~95% (non-condensing)
Data Display -- 16 letters x 4 lines industrial LCD screen
Operation keyboard -- 9 keys
Measuring range -- pH: 0.00~14.00, Accuracy±0.1pH ORP: 200~1000mV, Accuracy±1mV
Temperature range -- 0~100°C (Accuracy±1°C)
Output Interface -- pH dosing output, ORP dosing output, Alarm output
Network communication interface -- Rs485 communication protocol
Input interface -- pH probe, ORP probe
Dimension -- 320 (H)x296 (W)x146 (D)mm
Weight -- 3.2kg
Housing material -- ABS
Protection degree -- IP65

*Accessories are for display only. The details are subject to the actual order.

*Accessories are for display only. The details are subject to the actual order.

WATER QUALITY MONITOR

AUT-800

Free Chlorine Multifunctional Water Quality Monitor

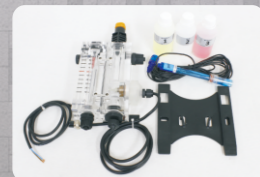

*Accessories are for display only.
The details are subject to the actual order.

- pH Measurement -- Range: 0-14, Resolution: ± 0.01
- CL Measurement -- Range: 0-200PPM, Resolution: ± 0.01 , Accuracy: 1%
- Temperature Measurement -- PT100, Range: 0-100°C, Resolution: 1°C, Accuracy: 1%
- Power Input -- 220V/50Hz
- Power -- 15W
- Signal Input -- External trigger (flow meter) input (15-30Vac/Vdc)
- Output -- 4-20mA, 2 dosing pump relay output (10A/220V)
- Dimensions -- 300 (H)x290 (W)x143 (D)mm
- Installation -- Wall-mounting
- Working Environment -- Temperature: 0-40°C, Relative Humidity: 0-95% (non-condensing)
- Weight -- 2.45kg
- Housing Material -- ABS
- Protection Degree -- IP65

16 Characters Double Line LCD Display

AUT-800 and AUT-042 using high quality electronic components and excellent housing material. It is a pool water quality intelligent monitoring system, designed to control chlorine content and pH value of swimming pool and SPA pool.

AUT-042

Dual Function Water Quality Monitor

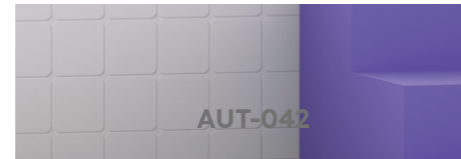

*Accessories are for display only.
The details are subject to the actual order.

- pH Measurement -- Range: 0-14, Resolution: ± 0.01
- ORP Measurement -- Range: $\pm 1500mV$, Resolution: 1mV, Accuracy: $\pm 1mV$
- Power Input -- 220V/50Hz
- Power -- 15W
- Signal Input -- External trigger (Flow meter) input (15-30Vac/Vdc)
- Output -- 4-20mA, 2 dosing pump relay output (10A/220V)
- Dimensions -- 300 (H)x290 (W)x143 (D)mm
- Installation -- Wall-mounting
- Working Environment -- Temperature: 0-40°C, Relative Humidity: 0-95% (Non-condensing)
- Weight -- 2.45kg
- Housing Material -- ABS
- Protection Degree -- IP65

INTEGRATED ION DISINFECTION MACHINE

ACSmart

Model	ACSmart 300	ACSmart 600
Dimensions	mm 391x186x273	391x186x273
Power/Frequency	V/Hz 220V/50Hz	220V/50Hz
Working Pressure	kg/cm ² 2.5	2.5
Maximum Water Flow	m ³ /h 28	28
Max Environmental Humidity	% 95	95
Temperature	°C 5-40	5-40
Connection Size	/ DN50	DN50
Suitable for Pool Volume	m ³ 30	60
Electrode Type	/ Y100	Y200



- Double fan design to prevent PCB overheating.
- Maximum 12V output.
- Power: 50W
- Wifi connection control device.
- Four touch buttons, simple interface.
- The screen displays the working status in real time.
- DC low voltage output, safety guarantee.
- Pipe connection, easy to install.
- Built-in overload and overcurrent protection function.
- Fine and compact appearance, occupy small space.
- Built-in circuit board, working time is adjustable.

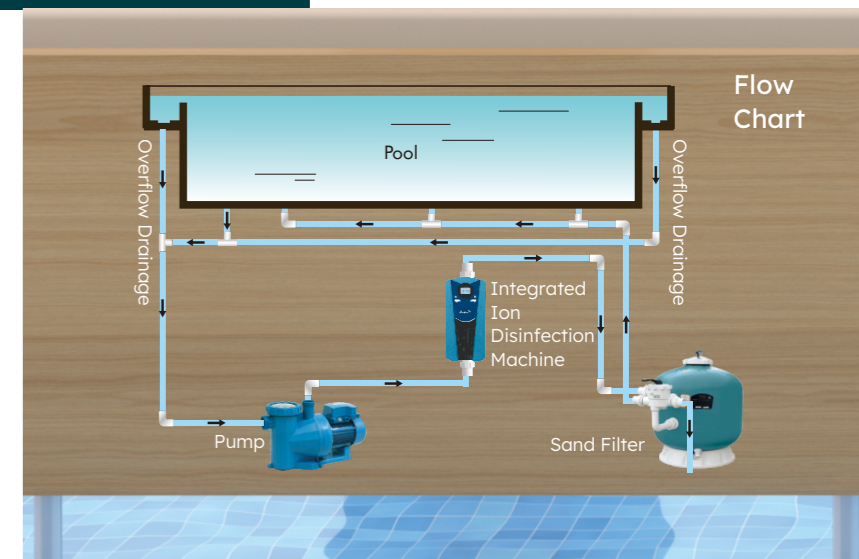

SALT CHLORINATOR

QSS Intelligent Control. Safe and Reliable Disinfection Method for Swimming Pool.

- Environment Temperature: 0°C-50°C.
- Environment Humidity: ≤85%.
- Well Ventilated.
- Away from other heat sources.
- Input Power: 220V/50Hz.

Salt Standard: salt content of pool water up to 3600PPM or more. It means 10,000 liters of pool water need to add not less than 36kg of pure salt.

Display the percentage of electrolytic yield, electrode voltage, electrode current and water salinity.

- You can set the operation time of the chlorinator, three time period a day can be set to automatically run, can be full-load operation, one key ECO energy-saving operation.
- Small and easy to install, you only need to connect inlet and outlet water pipes, power supply and add natural salt to the pool, and then it can be used.
- Titanium electrode, good corrosion resistance.

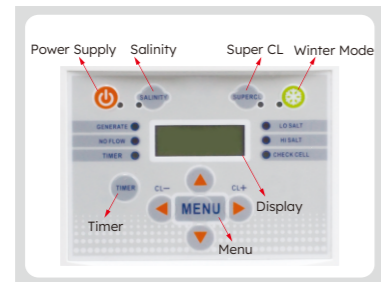
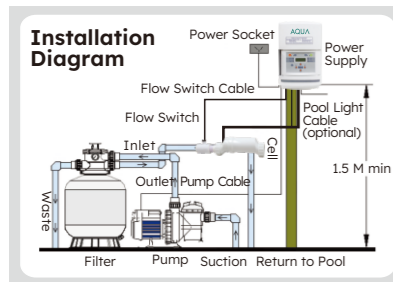

Model	Connection Size	Chlorine Production Rate (G/hour)	Suitable for Pool Volume (m³)	Flow Switch	Length (mm)	Width (mm)	Height (mm)	Weight (kg)
QSS35	DN40	35	85	Yes	220	130	360	8.5
QSS50	DN40	50	125	Yes	220	130	360	8.8

Cell Size : 335x118x100mm



DOSING PUMP

AC A Simple and Reliable Electronic Solenoid Dosing Pump.

A microprocessor controlled solenoid dosing pump, with a simple, stable operation.

Characteristics:

1. Advanced design concepts and excellent manufacturing process, creating a long membrane life.
2. Diaphragm is made of pure solid PTFE material, can be used compatibility with most of the chemicals.

- Enclosure Materials: PP.
- Protection Degree: IP65.
- Pump Head Materials: Pump body- PVDF (with manual priming valve).
- Valves: PVDF.
- Balls: Ceramic.
- Diaphragm: PTFE (the diaphragm has been tested over a period of 5 years).
- Flow Rate Manual Adjustment: 0-100%.
- Digital display flow rate, simply adjust the flow rate.



Model	AC-10	AC-20	AC-60
Power Supply	W/V/Hz 14/220/50	40/220/50	40/220/50
Flow	L/h 9	18	54
Maximum Pressure	Bar 10	16	5

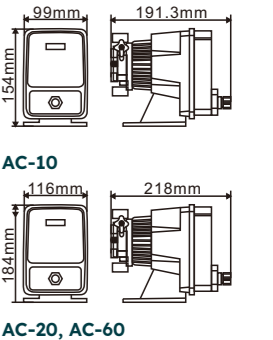

AUTOMATIC CHLORINE FEEDER

- CL** - CL-100, CL-200, CL-220 Suitable for SPA pool and small size pool.
- CL-500, CL-800, CL-1000 Suitable for big size and medium size pool.

Model	CL-100	CL-200	CL-220	CL-500	CL-800	CL-1000
Volume(lb)	4.2	9.0	9.0	50.0	80.0	100.0
LxH(mm)	120x410	165x390	165x390	225x567	225x927	225x1107





MONITORING DISINFECTION CASE DISPLAY

111

COROLLARY EQUIPMENT

Pool Lights:

To bring you a magnificent pool.

Note: When the wattage is the same and the voltage is 12V, the underwater light current is 20 times that of general lighting, the square of the embedded cable should be amplified accordingly.

Pool Fittings:

Swimming pool fittings, as essential parts of the swimming pool for you, enrich your selection range.



COUNTER-CURRENT SYSTEM

The best choice for counter-current swimming training in small and medium-sized swimming pools.

AJ-3000

- Power: 3.0kW/380V/50Hz
- Max. Flow: 400m³/h
- Counter-current Dimensions: 482x782x1000mm
- Electric Box Dimensions: 500x480x750mm
- Oil Pipe: 15m*2pcs/25kPa
- Shell Material: 316 stainless steel



- Using a powerful oil pump motor.
- Hydraulic drive, water and electricity are separated, safe and reliable.
- Detachable installation, convenient and fast, and simple maintenance.
- Frequency conversion control box, remote control, 4-speed adjustable.
- 316 stainless steel anti-corrosion plating shell, simple and elegant, corrosion-resistant.
- Large flow, high flow speed.

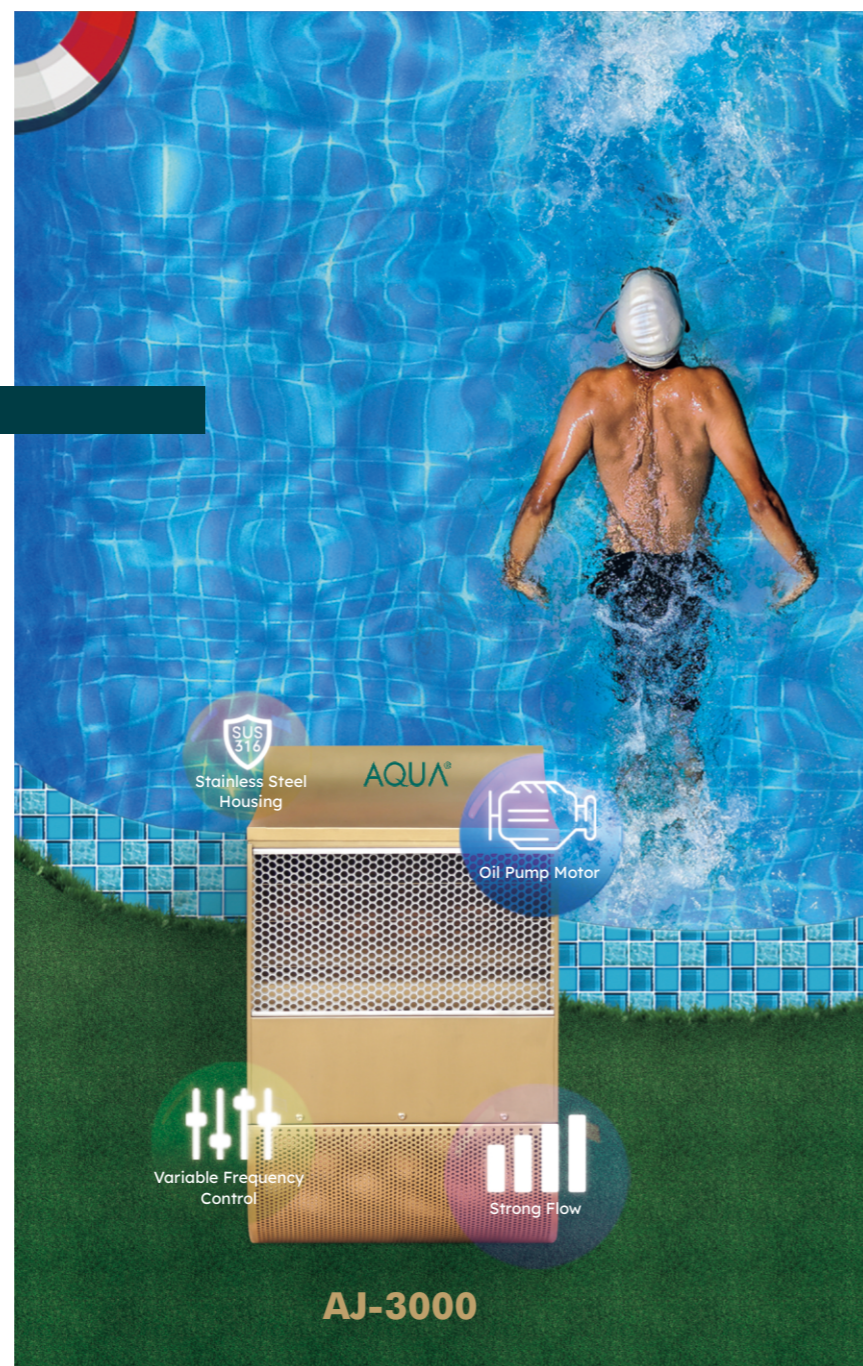
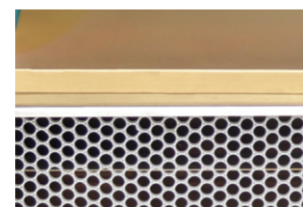

AJ-3000

STAINLESS STEEL COUNTER-CURRENT JET

Realize the dream of borderless swimming pool.

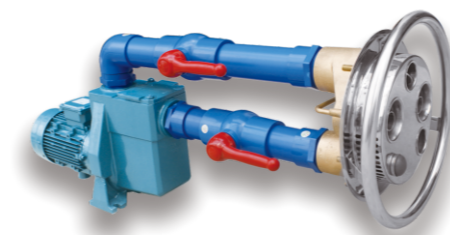

J-2000



The embedded part of the counter-current jet is made of copper metal. The polished water inlet/outlet and handle are made of AISI304 stainless steel. It can be installed on concrete, earth or prefabricated board walls. Suitable for 3-4kW large flow water pump. The nozzle is equipped with a bubble size control switch, a water flow size control switch, a pneumatic switch hose, a negative pressure air inlet interface, and a control electrical box (air switch or touch sensor switch) is optional.

Model	Pump Horsepower (HP)	Voltage (V)	Frequency (Hz)	Maximum Head (m)	Power Input (kW)	Maximum Flow (m ³ /h)
J-2000-40	4	380	50	15	3	51
J-2000-55	5.5	380	50	17.5	4	66

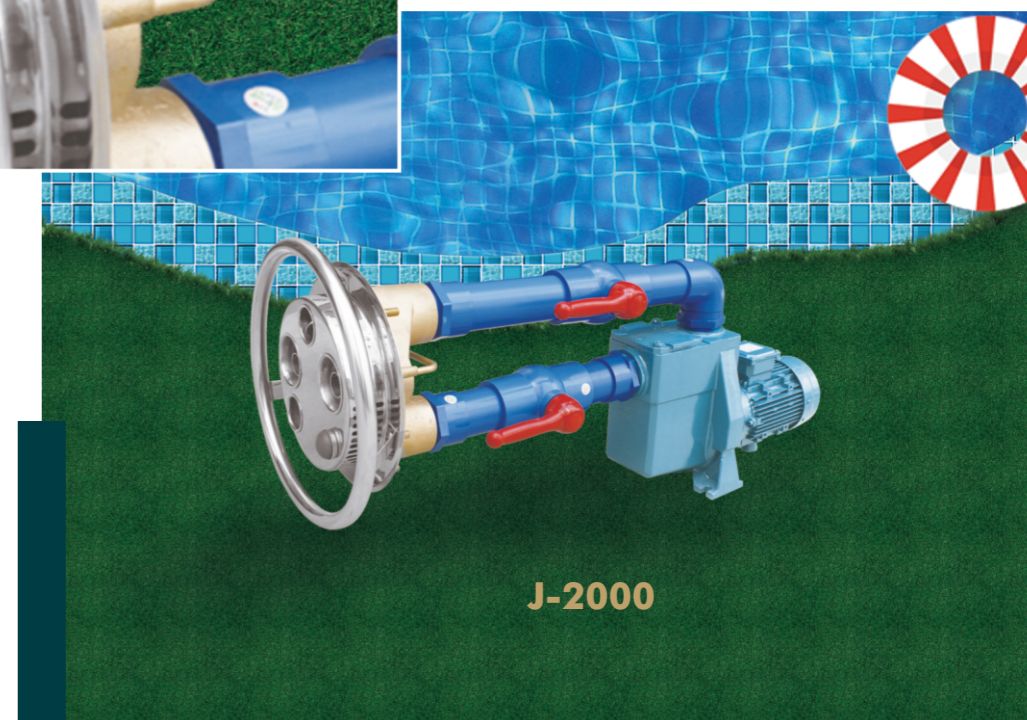

J-2000

Light up every corner of the swimming pool

POOL LIGHT

Waterproof, anti-corrosion, energy saving, environmentally friendly

» Wall-mounted Shell Type Pool Light

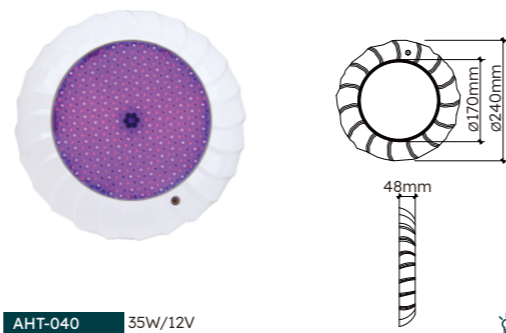

AHT-040 35W/12V

» Wall-mounted Stainless Steel Pool Light



ALE-18SN 18W/12V

» Wall-mounted Plastic Pool Light

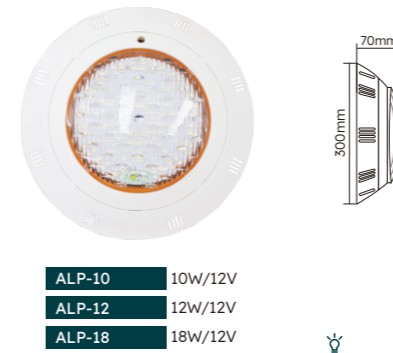

ALP-10 10W/12V
ALP-12 12W/12V
ALP-18 18W/12V

» Recessed Stainless Steel Pool Light



ALH-06 6W/12V
ALH-12 12W/12V
ALH-18 18W/12V
ALH-24 24W/12V

» Recessed Stainless Steel Pool Light

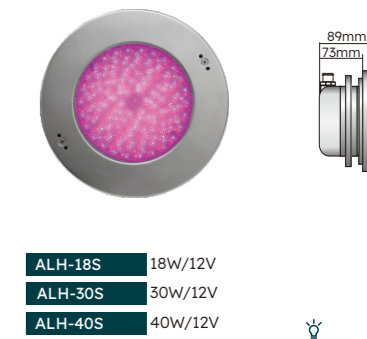

ALH-18S 18W/12V
ALH-30S 30W/12V
ALH-40S 40W/12V

» Wall-mounted Stainless Steel Pool Light

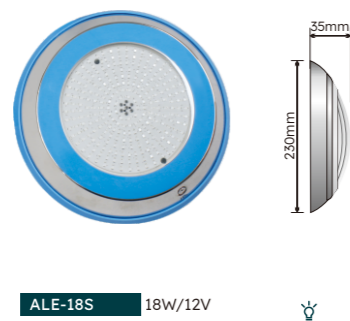

ALE-18S 18W/12V

» Wall-mounted Stainless Steel Pool Light

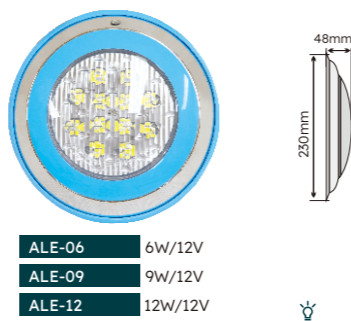

ALE-06 6W/12V
ALE-09 9W/12V
ALE-12 12W/12V

» Wall-mounted Stainless Steel Pool Light

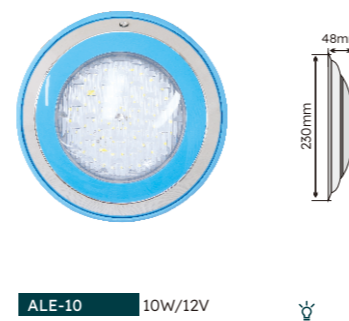

ALE-10 10W/12V

» Recessed Stainless Steel Pool Light



ALS-05110H 5W/12V

» Recessed Stainless Steel Pool Light



ALS-06160B 6W/12V
ALS-09160B 9W/12V

» Recessed Stainless Steel Pool Light



ALS-10160H 10W/12V

» Recessed Stainless Steel Pool Light

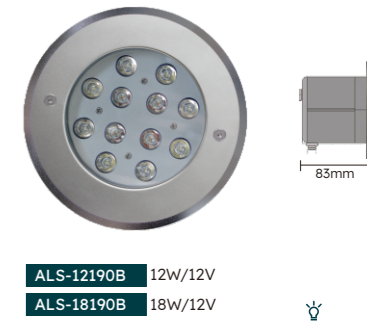

ALS-12190B 12W/12V
ALS-18190B 18W/12V

» Wall-mounted Stainless Steel Pool Light

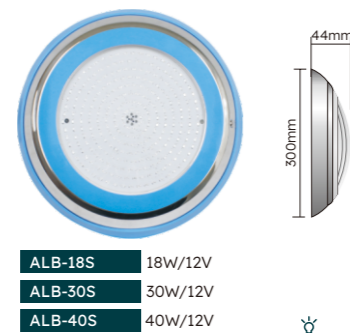

ALB-18S 18W/12V
ALB-30S 30W/12V
ALB-40S 40W/12V

» Wall-mounted Stainless Steel Pool Light

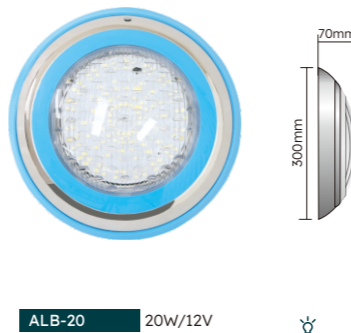

ALB-20 20W/12V

» Wall-mounted Stainless Steel Pool Light

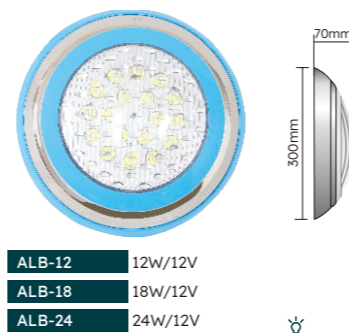

ALB-12 12W/12V
ALB-18 18W/12V
ALB-24 24W/12V

» Recessed Stainless Steel Pool Light



ALS-15190H 15W/12V

» Recessed Stainless Steel Pool Light



ALS-03110B 3W/12V

» Recessed Stainless Steel Pool Light
**Not applicable to RGB remote control.*



ALS-01 1W/12V

» Recessed Stainless Steel Pool Light



ALS-03L 3W/12V
ALS-35 35W/12V

POOL LIGHT

» Recessed Stainless Steel Pool Light



ALU-06 6W/12V

» Recessed Stainless Steel Pool Light



ALU-12 12W/12V
ALU-18 18W/12V
ALU-24 24W/12V

» Stainless Steel Landscape Light

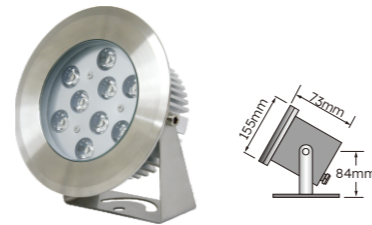

ALF-09N 9W/12V

» Stainless Steel Landscape Light

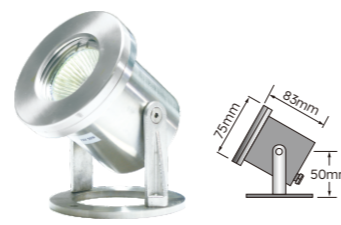

ALF-03S 3W/12V
ALF-35 35W/12V

» Water Proof Transformer 220V 50Hz/60Hz



TRA-50 50W
TRA-105 105W

» Water Proof Transformer 220V 50Hz/60Hz



TRA-150 150W
TRA-200 200W
TRA-300 300W
TRA-500 500W

» RGB Remote Control (Lamps need to be specially ordered)



Rated Power: 300W

» RGB Remote Control



Rated Power: 3000W

Optional Light Source:

Warm White 2800~3000K

White 6000~6500K

RGB

Blue $\lambda=465\sim467\text{nm}$

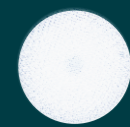

White

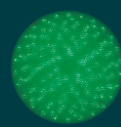

Green

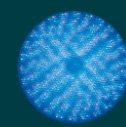

Blue

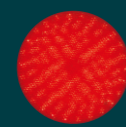

Red

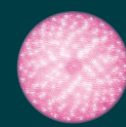

Pink

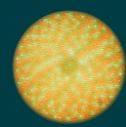

Combination

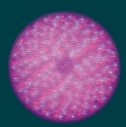

Combination

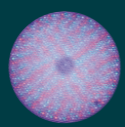

Combination

Aquatic Fitness Equipment

Aquatic Bike

Package Size:
910x910x190mm
Weight: 15kg

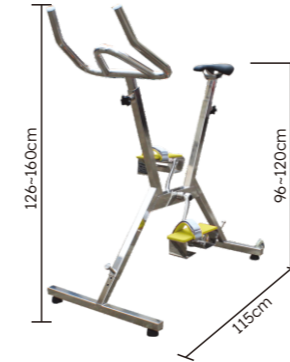

Aquatic Stepper

Package Size:
1110x1200x290mm
Weight: 24kg

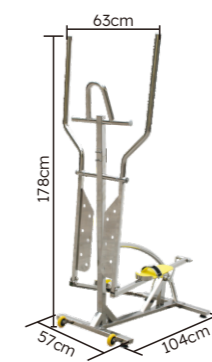

Stainless Steel Ladder SS304 & SS316



Embedded Parts

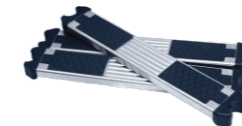

Non-slip Pedals are Optional



SF



SL



SM

Model	Size(mm)						
	A	B	C	D	E	F	G
SF-215	280	720	250	1300	180	500	490
SF-315	280	720	250	1550	180	500	490
SF-415	280	720	250	1800	180	500	490
SF-515	280	720	250	2050	180	500	490
SL-215	700	720	250	1320	180	500	-
SL-315	700	720	250	1570	180	500	-
SL-415	700	720	250	1820	180	500	-
SL-515	700	720	250	2070	180	500	-
SM-215	318	630	250	1310	180	500	-
SM-315	318	630	250	1560	180	500	-
SM-415	318	630	250	1810	180	500	-
SM-515	318	630	250	2060	180	500	-

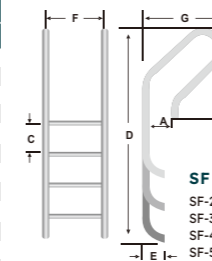

SF

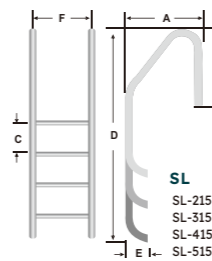

SL

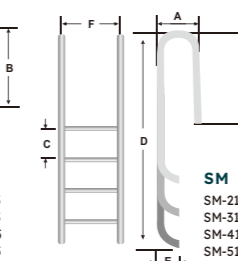

SM

Stainless Steel Pool Handrail

*The size can be customized. Customized products do not support returns or exchanges unless they have quality issues!

SP-3032

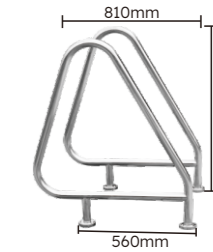

SP-3033

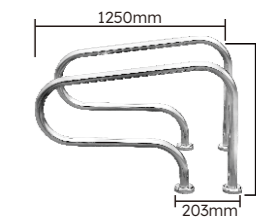

SP-3034



Scene Display >>



NANO MILK BATHMACHINE >>

Suitable for saunas, bath centers, resorts, SPA, hotels and modern luxury bathrooms.



ATM40-6PLUS

- Flow Rate: 8m³/h
- Head: 20m
- Power: 3kW
- Dimension: 800x600x1100mm
- Voltage: 380V/50Hz

- Manual control
- Automatic control
- Remote control
- Overload protection
- High voltage protection
- Phase loss protection
- Leakage protection

Nano milk bath machine produces nano-sized highly oxygenated water molecules through high-frequency magnetic wave oscillation. The principle of nano milk bath machine is molecular collision and ultra-high frequency magnetic wave cutting to generate negative ions and ultrasound to reduce chlorine in water. After nano-scaling, negative ions and water molecules quickly penetrate the skin, deep clean, increase oxygen content, promote blood circulation, activate cell repair and delay aging, which is comparable to professional SPA.

SPA nano milk bath machine produces 1.2 billion tiny bubbles per minute to form negative ions, eliminate tension, improve allergies, whiten, exfoliate, detoxify, anti-aging, relieve stress, and calm. The tiny bubbles peel off lactic acid toxins, and aging keratin without hurting the skin, making the skin smooth and delicate. It has a sterilizing, cleansing and whitening effect on acne and blackheads, and prevents skin problems. The SPA process effectively improves stress and enjoys health and wellness.

Starting Block >>



AQ-9099
Olympic Starting Block



AQ-9100
795x625x400mm
Olympic Starting Block



AQ-9102
Olympic Starting Block

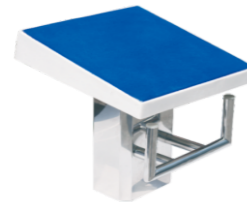

AQ-9095
500x500x450mm
Standard Competition Starting Block

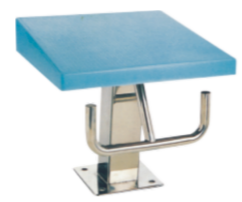

AQ-9096
500x500x450mm
Pool Starting Block



AQ-9098
580x560x510mm
Luxury Competition Starting Block



AQ-9100A 1000x800x300mm
AQ-9100B 1480x800x300mm
AQ-9100C 2500x800x300mm
Platform for Starting Blocks

Massage Seat/Bed >>



2100x860x530mm
Luxury Space Massage Bed



710x890mm
Luxury Space Massage Seat



600x900mm
Luxury Massage Seat



AQ-0016
1800x685mm
Hydromassage Bed

Grating >>



AQ-2518/AQ-2520
AQ-2525/AQ-2530
AQ-2535/AQ-2540
Grating



AQ-2518SW
AQ-2525SW
AQ-2530SW
Grating (Bone Color)



AQ-2618
AQ-2625
AQ-2630
Grating



AQ-2725/AQ-2730
AQ-2735/AQ-2740
Grating

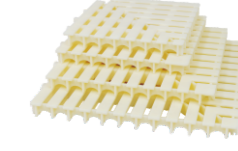

AQ-2818F/AQ-2820F
AQ-2825F/AQ-2830F
AQ-2835F/AQ-2840F
90° Grating Corner

Floor Mat >>

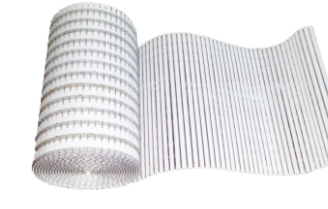

1x20m
Germany Imported Non-slip Mat



AQ-10100
1x10m
Floor Mat

Swimming Pool Lane Line >>



AQ-9083
Ø110mm
Lane Line



AQ-9112
Ø120mm Ø150mm
Lane Line

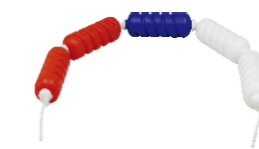

AQ-9106
Ø60mm Ø90mm
Lane Line



Lane Line Hook



SP-1046
Lane Line Tightener



SP-1040
Lane Line Block



Lane Line Roller

Wall Skimmer >>

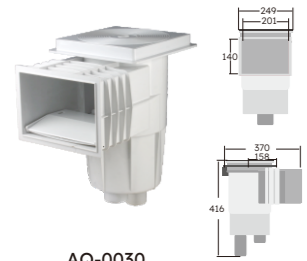

AQ-0030
Wall Skimmer

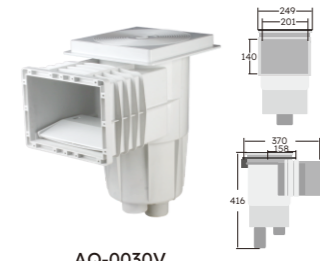

AQ-0030V
Wall Skimmer(Vinyl Pool)

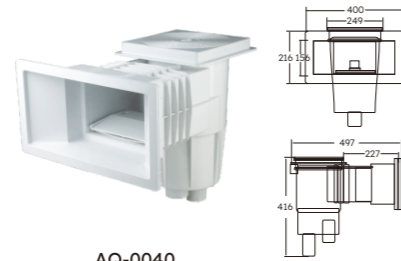

AQ-0040
Wall Skimmer

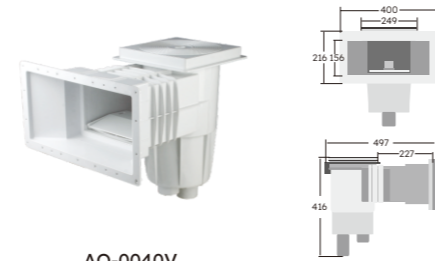

AQ-0040V
Wall Skimmer(Vinyl Pool)

Hair Strainer >>

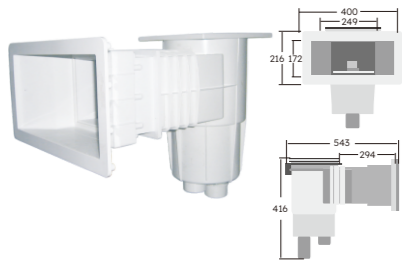

AQ-0060
Wall Skimmer

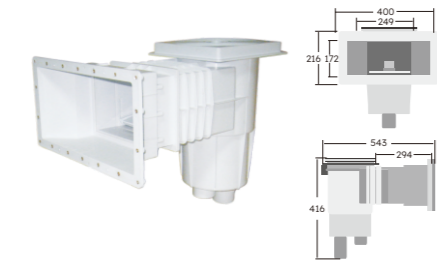

AQ-0060V
Wall Skimmer(Vinyl Pool)



Y-065-250
Stainless Steel Hair Strainer



YV-50-250
Stainless Steel Quick Opening
Hair Strainer

Main Drain >>



AQ-2830S
Ø210x30mm
Stainless Steel Main
Drain Cover



AQ-2812S
300x300x30mm
Stainless Steel Main
Drain Cover

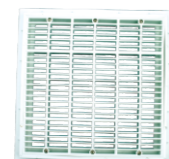

AQ-2812/SP-1032
300x300x30mm
Main Drain Cover



SP-1031
253x253x30mm
Main Drain Cover



AQ-2813 336x336 (298x298)mm
AQ-2814 263x263 (224x224)mm
Anti-vortex Main Drain Cover



AQ-2816
523x523mm
Anti-vortex Main Drain Cover

Main Drain >>



AQ-2850
Ø230x175h(mm)
2"Female thread
Main Drain



AQ-2850V
Ø230x175h(mm)
2"Female thread
Main Grain
(Vinyl Pool)



AQ-2830
SP-1030
Ø210x30mm
Main Drain Cover

Wall Return >>



SP-1425
1.5"/2"/2.5"/3"/4"
Plug-in Wall Return



SP-1425S
1.5"/2"/3"/4"
Stainless Steel
Plug-in Wall Return



AQ-2825
1.5"/2"
Wall Return



AQ-2825V
Ø109x67mm
Inner diameter 50mm/
2"Male thread
Wall Return
(Vinyl Pool)



AQ-2828V
Ø90x110mm
1.5" Female thread/
2" Male thread
Wall Return
(Vinyl Pool)



AQ-1006V
Ø119x66.5mm
Inner diameter 50mm/
2"Male thread
Wall Return
(Vinyl Pool)

Wall Return >>



1.5"/2"
Check Valve



SP-1424/AQ-2824
1.5"/2"/3"/4"
Wall Return



AQ-2824S
1.5"/2"
Stainless Steel
Wall Return

Gutter Grain >>



AQ-2819
SP-1019
1.5"/2"
Gutter Grain



AQ-2819S
2"Male thread
Stainless Steel Gutter Grain



AQ-2851
Ø119x66.5mm
Inner diameter 50mm/
2"Male thread
Thread Wall Return



AQ-2852
Ø119x66.5mm
Inner diameter 50mm/2"
Smooth Surface Adhesive
Wall Return



AQ-00324
1.5"/2"Male thread
Wall Return Connector

Suction Nozzle >>



SP-1855
1.5"/2"
Plug-in Suction
Nozzle



AQ-2822S
2" Male thread
Stainless Steel
Suction Nozzle



AQ-2853
Ø119x66.5mm
Inner diameter 50mm/2" Male thread
Thread Suction Nozzle



AQ-2854
Ø119x66.5mm
Inner diameter 50mm/2"
Smooth Surface Adhesive
Suction Nozzle



AQ-2827V
Ø90x93mm
1.5" Female thread/2" Male thread
Suction Nozzle
(Vinyl Pool)



AQ-2822
1.5" Female thread/2" Male thread
Vacuum Suction
Nozzle



AQ-2822A
AQ-2822B
Ø55mm
Vacuum Suction
Cover

SPA Fittings >>



H: 1370mm
In: 2" Female thread
Water Output Width:
500/600mm
Flow: 25m³/h
Water Curtain Nozzle



H: 800mm
In: 2" Female thread
Water Output Width:
500/600mm
Flow: 25m³/h
Arc Hook Water Curtain



Ø63x2500x2200mm(H)
Vichy Shower Nozzle



Ø300mm
1.5"/2"
Sunflower Nozzle

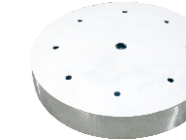

Ø300mm
1.5"/2"
Fountain Device

Jet >>



SP-1434
1.5"
Massage Jet



SP-2834
1.5"/2"
Plug-in Massage Jet



SP-1450T
Ø142x195mm
1.5"
Riptide Jet



SP-2834T
1.5"/2"
Stainless Steel
Plug-in Massage Jet

Sprinkler Head >>



Nine Holes



Bullet



Small Duckbill

Sprinkler Head >>

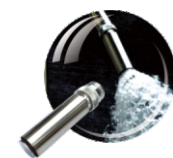

Umbrella Hammer

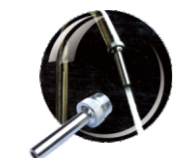

Direct Injection

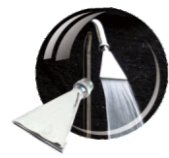

Large Duckbill



Single Hole



Straight Mouth



Gas-filled



Four Holes

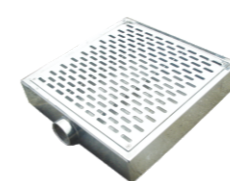

350x350mm
1.5"/2"
Oxygen Enrichment
Air Pad

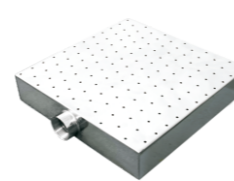

350x350mm
1.5"/2"
Oxygen Enrichment
Air Pad



350x350mm
1.5"/2"
Foot Massage Pad



Ø300mm
1.5"/2"
Round Massage Pad

Other Fittings >>



AQ-9055
Floating
Thermometer



AQ-9056
Floating
Thermometer



300x300mm
Non-slip
Rubber Mat

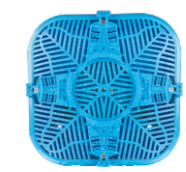

AWS-015
Rate: 80-20000Hz
Size: 165x165x35mm
Underwater
Loudspeaker



AR-5
SPA Switch



AR-6
SPA Switch



AT-SA
SPA Switch



AT-XA
SPA Switch



AQ-1844
Pneumatic Switch

Vacuum Head >>

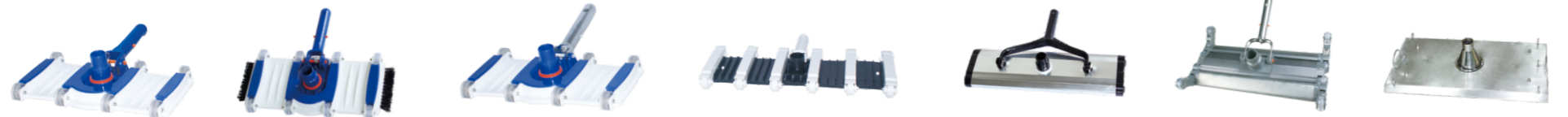

AQ-9003 14" Luxury Vacuum Head
 AQ-9008 14" Luxury Vacuum Head with Brush
 AQ-9012 14" Stainless Steel Handle Luxury Vacuum Head
 AQ-9013 19" Luxury Vacuum Head
 AQ-9009 19" Vacuum Head with Aluminum Back
 AQ-9010 19" Aluminum Vacuum Head
 AQ-9011 28"/40" Stainless Steel Vacuum Head

Brush >>



AQ-9020 6" Stainless Steel Brush
 AQ-9021 10" Plastic Brush
 AQ-9022 10" Stainless Steel Brush
 AQ-9023 14" Plastic Brush
 AQ-9024 14" Stainless Steel Brush
 AQ-9025 18" Curving Brush with Aluminum Back
 AQ-9026 18" Plastic Brush
 AQ-9027 18" Stainless Steel Brush

Leaf Skimmer >>

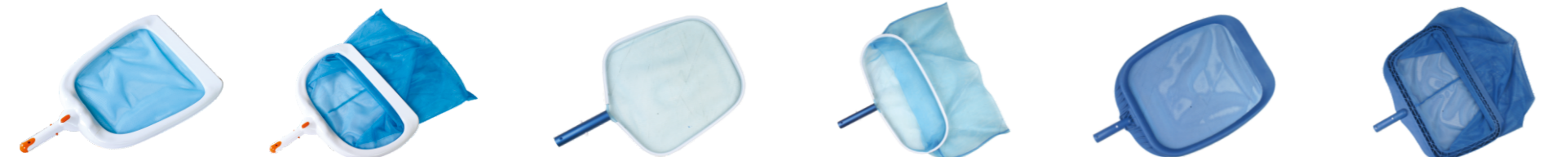

AQ-1001 Luxury Leaf Skimmer with Easy Button
 AQ-1002 Luxury Deep Leaf Skimmer with Easy Button
 AQ-9015 Aluminum Leaf Skimmer
 AQ-9016 Aluminum Deep Leaf Skimmer
 AQ-9017 Plastic Leaf Skimmer
 AQ-9018 Plastic Deep Leaf Skimmer

Other Cleaning Accessories >>



AQ-9060(12m 1.5")
 AQ-9061(15m 1.5")
 AQ-9062(30m 1.5")
 AQ-9063(30m 2")
 Suction Hose
 AQ-9065(7.5m)
 AQ-9066(15m)
 AQ-9067(30m)
 Blowdown Hose
 AQ-9075 Test Kit
 AQ-9077(PH)
 AQ-9078(CL)
 8 Ounce Reagents
 AQ-9091 Detachable Stainless Steel Cart
 AQ-5000 (Adjustable length 1.05-1.6m) (12V)
 Portable Hand-held Electric Suction Cleaner

Life-saving Tools >>



AQ-9082 630x200mm Life-saving Hook
 AQ-9082B Life-saving Hook
 AQ-9081 Inter diameter 440mm, Outer diameter 710mm Lifebelt
 AQ-9026 Head Immobilizer
 AQ-9203 1000x150x100mm Life-saving Buoy
 AQ-9205 2000mm*8mm Lifeline
 AQ-9204 1850x460x65mm First Aid Board

Other Fittings >>



AQ-9090 980x800x1900mm SS304 Life-saving Chair
 AQ-9202 1250x950x1950mm Plastic Life-saving Chair
 AQ-9087 2x2.4m
 AQ-9089 3x3m Telescopic Poles
 Foul Recall Line
 Backstroke Marker Line
 Butterfly Valve
 AQ-2823 130x130x84mm Junction Box